



Product Catalogue

3-phase Induction Motors

IE2

**Energy Efficient
Motors
series 2SIE**



Certificates

Cantoni Motor SA
 ISO 9001
 Since September 30, 1999



Besel SA
 ISO 9001
 Since July 21, 1995



Celma Indukta SA
 ISO 9001
 Since April 1, 1993



ISO 14001
 Since November 15, 1999

Emit SA
 ISO 9001:2008
 ISO 14001:2004
 Since January 23, 2012





since 1948

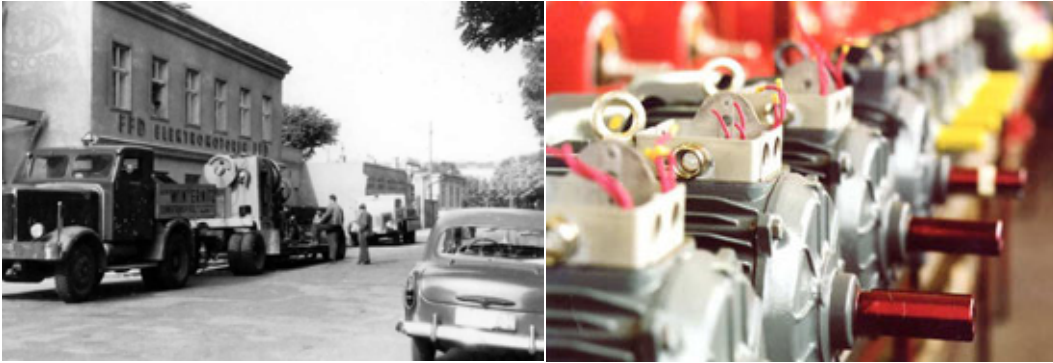

Product range beginning from 0,04kW up to 5000kW

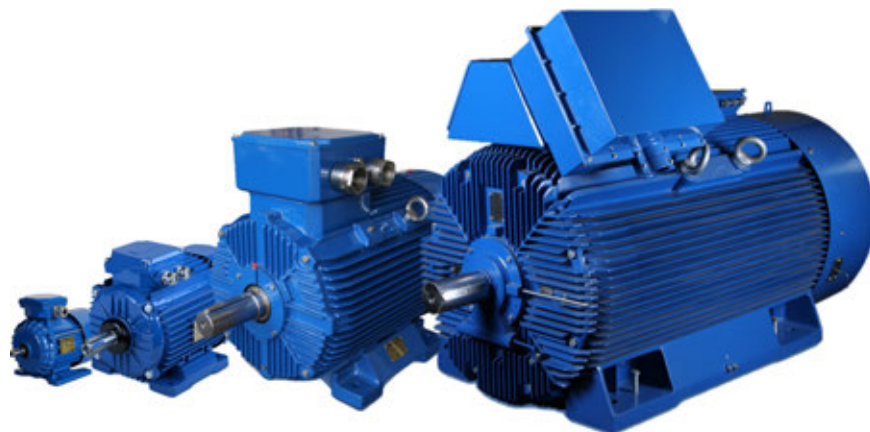

„FFD part of Cantoni Goup” in numbers

- ~ 1900 employees
- Annual production ~ 1.000.000 motors
- Covered area ~ 120.000 m²

OUR SOLUTION FOR YOUR POWER!

Contents

General information

pages 5-14

- Introduction to SIE motors*
- Efficiency of motors*
- Ratings-tolerances*
- Standards*
- Insulation classification*
- Terminal box*
- Vibration and noise level*
- Degree of protection*
- Mounting arrangements*
- Bearings*
- Permissible loads on the shaft end*
- Housing, endshields*
- Description of the customised executions*
- Ordering information*

Technical data

- 2 pole motors **page 15**
- 4 pole motors **page 16**
- 6 pole motors **page 17**

Dimensional drawings

pages 18-23

List of motor parts

pages 24-25

Production program

pages 26-27

INTRODUCTION

New efficiency classes for the low-voltage three-phase motors (IE = International Efficiency).

Along with the international discussion on energy efficiency a worldwide harmonized energy efficiency standard classification system has been established for low-voltage three-phase asynchronous motors. For many years low-voltage three-phase motors in the European Union have been sold in three efficiency classes EFF3, EFF2 and EFF1. Aside from this, many different efficiency classification systems have been introduced and well-proven in many countries all over the world.

This was the reason for the International Electrotechnical Commission IEC to develop and publish an energy efficiency standard which replaces all previous national issues. In parallel IEC developed and issued a new standard for determining motor efficiency. The new standard IEC 60034-30-1 defines and harmonizes worldwide the efficiency classes IE1, IE2, IE3 and IE4 for low-voltage three-phase motors in the power range from 0.12 kW to 1000 kW (2p=2, 4, 6, 8)

IE1 = Standard Efficiency

IE2 = High Efficiency

IE3 = Premium Efficiency

According to IEC 60034-30-1 standard the efficiency has to be determined according to the new requirements given in the IEC 60034-2-1 standard.

According to the Commission Regulation (EC) No 640/2009 (introduced in July 2009) including Commission Regulation (EC) No 4/2014 the required efficiency class of general-purpose motors with 2p=2, 4, 6 (introduced to the market in the future) will be as follows:

From 1 January 2017: motors with a rated output between 0.75 - 375 kW shall have a minimum efficiency class of IE3, or IE2 if they are operated/equipped with electronic speed control (VSD).

Electronic speed control is carried out using a frequency converter (VSD) that adjusts the speed of the motor - and therefore the torque produced - based on the energy needed.

EFFICIENCY OF MOTORS

The present catalogue describes the electric motors which belong to the efficiency class IE2 (high Efficiency)

Comparison between the efficiency of FFD motors (for example 2p=4) and efficiency class IE2/IE3 requirements according to the IEC 60034-30-1.

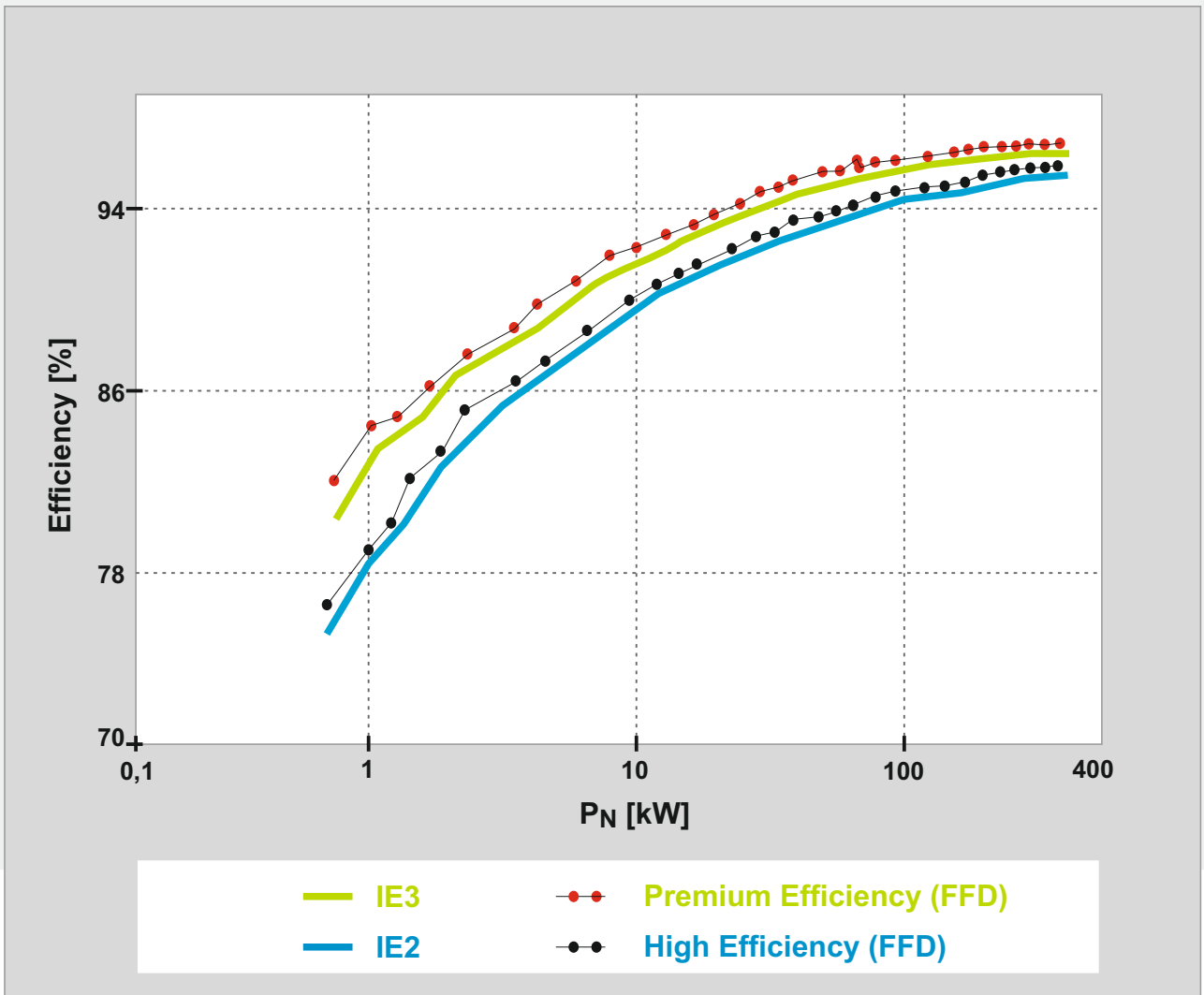

The efficiency class system specified under IEC 60034-30-1 is valid for low voltage three phase squirrel cage induction motors with the following specifications:

- Rated voltage up to 1.000 V
- Rated output between 0.12 kW and 1000 kW
- Either 2, 4, 6 or 8 poles
- Rated on the basis of continuous duty (S1)
- Supplied directly from mains
- With ambient temperature within the range of -30°C ÷ +60°C
- With altitude up to 4000 m. a.s.l.

Motors with flanges, feet and/or shafts with mechanical dimensions different from IEC 60072-1 are also covered by this standard.

RATINGS - TOLERANCES

Permissible deviations between real values and catalogue values according to the IEC 60034-1:

Power factor $\cos \varphi$	$\Delta \cos \varphi = -1/6 (1 - \cos \varphi_N)$
Efficiency η	$\Delta \eta = -15\% (100 - \eta_N)$ for $P_N \leq 150 \text{ kW}$ $\Delta \eta = -10\% (100 - \eta_N)$ for $P_N > 150 \text{ kW}$
Speed n	$\Delta n = \pm 20\% (n_s - n_N)$ for $P_N > 1 \text{ kW}$ $\Delta n = \pm 30\% (n_s - n_N)$ for $P_N \leq 1 \text{ kW}$
Locked rotor current I_L/I_N	$\Delta(I_L/I_N) = +20\% (I_L/I_N)$
Locked rotor torque T_L/T_N	$\min(T_L/T_N) = -15\% (T_L/T_N)$ $\max(T_L/T_N) = +25\% (T_L/T_N)$
Breakdown torque T_B/T_N	$\Delta(T_B/T_N) = -10\% (T_B/T_N)$
Moment of inertia J [kgm ²]	$\Delta J = \pm 10\% J$
Sound pressure level L_{pA} [dB]	$\Delta L_{pA} = +3 \text{ dB } /A/$

STANDARDS

The electric motors are manufactured according to the international standards:

Rating and performance	IEC 60034-1
Methods for determining losses and efficiency	IEC 60034-2-1
Classification of degrees of protection	IEC 60034-5
Methods of cooling	IEC 60034-6
Symbols of construction and mounting arrangements	IEC 60034-7
Terminal markings and direction of rotation	IEC 60034-8
Noise limits	IEC 60034-9
Dimensions and output of electric machines	IEC 60072-1
Vibration limits	IEC 60034-14

New IEC standards regarding efficiency classes (IEC 60034-30-1) and efficiency measurements (IEC 60034-2-1)

The resulting efficiency values differ from those obtained under the previous IEC 60034-2:1996 testing standard.
It must be noted that the efficiency values are only comparable if they are obtained using the same measuring method.

EU Regulation 640/2009 and 4/2014 adapted on 6 January 2014

Commission Regulation 640/2009, adapted on 22 July 2009, specifies the requirements regarding the ecodesign of electric motors and the use of electronic speed control (VSD).

IE1
IE3
IE2

All the motors are manufactured according to Quality Assurance System consistent with ISO 9001.

ISO9001

The motors covered by the present catalogue comply with the regulations and standards effective in other countries, consistent with IEC standards.

IEC

All the motors described in the present catalogue are provided with CE mark.

CE

INSULATION CLASSIFICATION

The insulation system of an electric motor is determined by a given insulation class on the basis of its thermal resistance. This thermal resistance should be guaranteed by the entire set of electric insulating materials used in the motor insulating system.

Thermal resistance classification is related to the temperature of the hotspot in the insulation occurring during rated operating conditions of the electric motor, allowing for the highest permissible rise in average temperature.

This rise should be selected so that at the highest permissible ambient temperature, the temperature of the hotspot in insulation will not exceed the value assigned to a given thermal resistance class.

Symbols of thermal resistance classes (permissible insulation temperatures at 40°C ambient temperature)

Symbol	Temperature [°C]
A	105
E	120
B	130
F	155
H	180

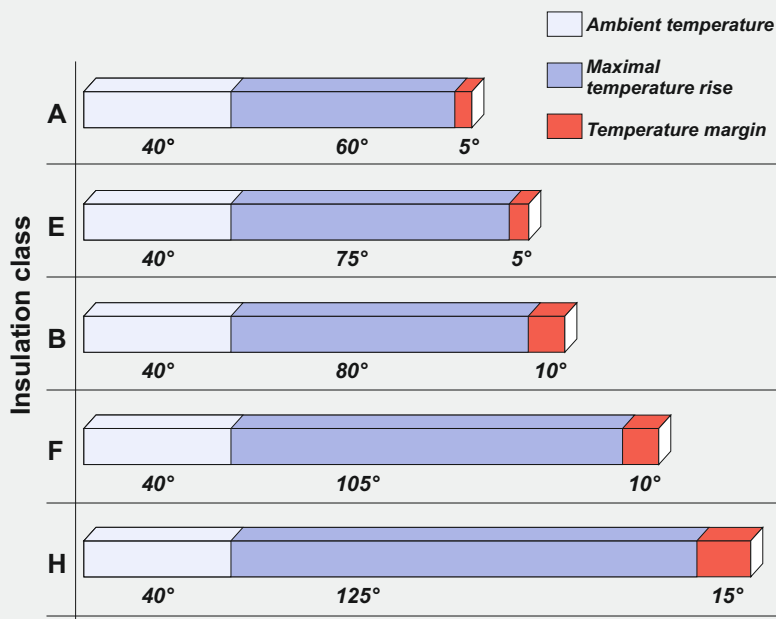

Insulation class F in an electric motor means that at ambient temperature of 40°C the temperature rise of the winding may be max. 105°C with the additional temperature margin of 10°C (under specified measuring conditions in accordance with the IEC 60034-1 standard).

Class F

The standard motors made by Cantoni Motor in their basic version have the insulation class F while the temperature rise is for class B. This means longer life for motors.

For special request we can deliver motors equipped with insulation class H.

Strengthened insulation system gives possibility to safe operation with frequency converters.

MOTOR FEET

Motors with frame size ≤ 132 have screwed feet.

Motors with frame size > 132 up to 315 have screwed feet or feet integrated with the motor housing.

Motors with frame size from 355 have feet integrated with the motor housing.

TERMINAL BOX

The terminal boxes of low voltage motors have threaded inlet holes designed for mounting cable glands. The box contains a terminal board with marked terminals making possible connection of supply cables.

In addition, terminal boxes may be provided with additional terminals connected to the ends of thermal protection or anticondensation heater circuits and extra glands to connect these circuits.

Low voltage high-power motors contain terminal boxes with cable gland seals.

The circuits of thermal protection and anticondensation heaters could be connected to separate terminal boxes.

Inside the boxes there are special clamps used to ground the supply cable armouring.

VIBRATION LEVEL AND NOISE LEVEL









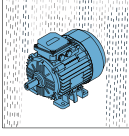
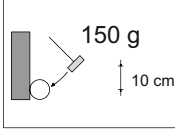

The rotor balancing method guarantees that a standard vibration level A is maintained in accordance with the IEC 60034-14 and a standard sound power level is maintained in accordance with the IEC 60034-9. On customer's demand the motors can be made with reduced vibration or noise level.

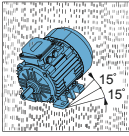
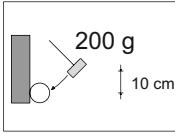
level A

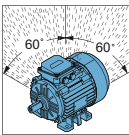
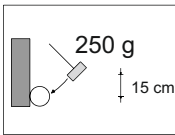
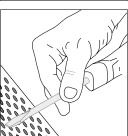
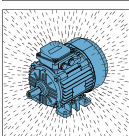
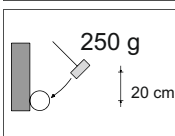
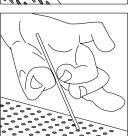
INTERNATIONAL PROTECTION MARKING IP

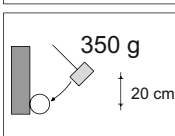
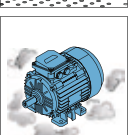
According to the IEC 60034-5 standard the electric motors are provided with IP code which determines the degree of protection (ensured by the housing) against penetration of solid matter and fluids.

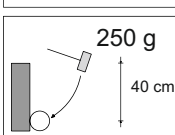
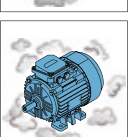
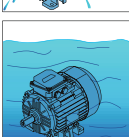
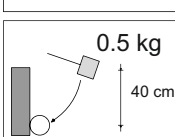
IP55

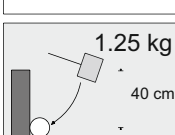
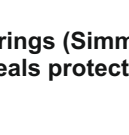
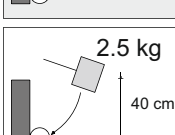
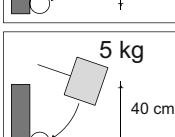
PROTECTION AGAINST PENETRATION OF SOLID MATTER		PROTECTION AGAINST PENETRATION OF FLUIDS		IK	MECHANICAL PROTECTION		
1st digit	DESCRIPTION	2nd digit	DESCRIPTION	3rd digit	DESCRIPTION		
				00	No protection		
0	 Not protected	0	 Not protected	01	 Striking energy: 0.15 J		
	 Protected against solid bodies larger than 50 mm		1		 Protected against vertically falling drops of water	02	 Striking energy: 0.20 J
	 Protected against solid bodies larger than 12 mm		2		 Protected against vertically falling drops of water up to 15°	03	 Striking energy: 0.37 J
	 Protected against solid bodies larger than 2.5 mm		3		 Protected against rain up to 60°	04	 Striking energy: 0.50 J
	 Protected against solid bodies larger than 1 mm		4		 Protected against rain falling from any direction	05	 Striking energy: 0.70 J
	 Protected against deposition of dust		5		 Protected against sprayed water from any direction	06	 Striking energy: 1 J
	 Totally protected against deposition of dust		6		 Protected against temporary immersion	07	 Striking energy: 2 J
		7	 Protected against immersion between 0.15 and 1 m		08	 Striking energy: 5 J	
		8	 Protected against immersion at preset pressure and time		09	 Striking energy: 10 J	
					10	 Striking energy: 20 J	

All FFD standard motors are manufactured with IP 55 degree of protection according to the standard in force (IEC 60034-5). The following table lists its characteristics.



Each size 80 to 180 motor is equipped with seal rings (Simmerring or V-ring) on drive side and on non drive side. Labyrinth seals protect the motors from size 200 and above.

The terminal box is sealed with a gasket.

Motors with a higher degree of protection are available on request.

MOUNTING ARRANGEMENTS

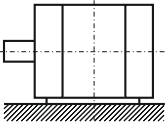
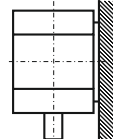
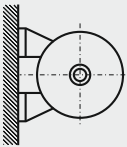
According to the IEC 60034-7 standard

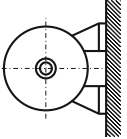
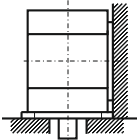
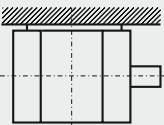
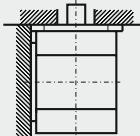
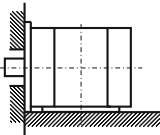
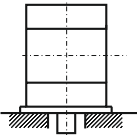
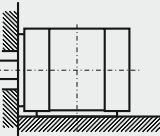
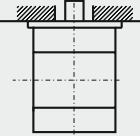
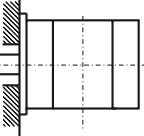
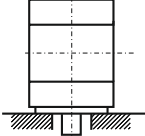
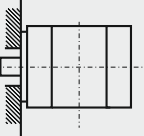
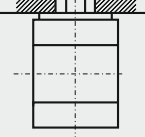
Horizontal shaft				Vertical shaft			
	Designation		Frame size		Designation		Frame size
	Code II	Code I			Code II	Code I	
	IM 1001	IM B3	56 ÷ 500		IM 1011	IM V5	56 ÷ 315 without 3SIE 315 M6B,C,D
	IM 1051	IM B6	56 ÷ 280		IM 1031	IM V6	56 ÷ 315 without 3SIE 315 M6B,C,D
	IM 1061	IM B7	56 ÷ 280		IM 2011 or IM 2111	IM V15	56 ÷ 355
	IM 1071	IM B8	56 ÷ 280		IM 2031 or IM 2131	IM V36	56 ÷ 355
	IM 2001	IM B35	56 ÷ 500		IM 3011	IM V1	56 ÷ 500
	IM 2101	IM B34	56 ÷ 132		IM 3031	IM V3	56 ÷ 280
	IM 3001	IM B5	56 ÷ 315 without 3SIEK 315 M6B,C,D		IM 3611	IM V18	56 ÷ 180
	IM 3601	IM B14	56 ÷ 132		IM 3631	IM V19	56 ÷ 180

* Other mounting arrangements available on special request

PERMISSIBLE LOADS ON THE SHAFT END

Frame size	Number of poles	Horizontal operation		Vertical operation			Frame size	Number of poles	Horizontal operation		Vertical operation		
		$F_R(x=0)$	$F_R(x=\max)$	F_p	F_{a1}	F_{a2}			$F_R(x=0)$	$F_R(x=\max)$	F_p	F_{a1}	F_{a2}
		[kN]		[kN]					[kN]		[kN]		
2SIE 80	2	0,33	0,27	0,09	0,06	0,12	2SIE 225 S	4	4,20	3,40	3,20	2,50	4,10
2SIE 80	4	0,44	0,37	0,12	0,09	0,15	2SIE 225 M	2	3,30	2,80	2,50	1,90	3,30
2SIE 90	2	0,68	0,44	0,68	0,35	0,38	2SIE 225 M	4	4,10	3,30	3,20	2,30	4,20
2SIE 90	4	0,78	0,44	0,78	0,35	0,38	2SIE 225 M	6	4,70	3,80	4,00	3,00	5,30
2SIE 90	6	0,96	0,44	0,96	0,35	0,38	2SIE 250 M	2	4,10	3,40	3,10	2,30	4,10
2SIE 100	2	0,88	0,46	0,90	0,28	0,40	2SIE 250 M	4	5,20	4,30	3,90	2,90	5,20
2SIE 100	4	1,06	0,46	0,98	0,38	0,40	2SIE 250 M	6	5,60	4,60	5,00	3,60	6,70
2SIE 100	6	1,20	0,46	1,10	0,38	0,40	2SIE 280 S	2	3,90	3,30	3,10	2,00	4,40
2SIE 112	2	1,00	0,48	1,00	0,40	0,45	2SIE 280 S	4	6,70	5,70	5,00	3,60	6,80
2SIE 112	4	1,45	0,48	1,40	0,40	0,45	2SIE 280 S	6	7,70	6,60	5,80	4,20	7,70
2SIE 112	6	1,62	0,48	1,60	0,40	0,45	2SIE 280 M	2	3,80	3,20	3,00	1,90	4,50
2SIE 132	2	1,82	0,66	1,90	0,43	0,60	2SIE 280 M	4	6,50	5,50	4,90	3,40	6,90
2SIE 132	4	2,10	0,66	2,20	0,45	0,60	2SIE 280 M	6	7,40	6,30	5,70	3,90	7,90
2SIE 132	6	2,80	0,66	2,80	0,50	0,60	2SIE 315 S	2	3,60	3,10	3,00	1,60	4,70
2SIE 160	2	2,22	0,98	2,30	0,92	0,95	2SIE 315 S	4	6,20	5,20	4,90	3,10	7,20
2SIE 160	4	2,40	0,98	2,40	0,92	0,95	2SIE 315 S	6	7,00	5,90	5,60	3,80	7,80
2SIE 160	6	2,85	1,10	2,90	0,98	1,00	2SIE 315 MA	2	3,30	2,80	2,90	1,40	4,80
2SIE 180	2	2,92	1,30	3,00	1,10	1,20	2SIE 315 MB	2	2,90	2,50	2,80	1,10	5,00
2SIE 180	4	3,60	1,30	3,60	1,10	1,30	2SIE 315 MA	4	5,80	4,80	4,70	2,70	7,30
2SIE 180	6	4,00	1,80	4,10	1,40	1,70	2SIE 315 MB	4	5,40	4,50	4,60	2,40	7,50
2SIE 200 LA	2	3,00	2,50	2,30	1,80	2,90	2SIE 315 MA	6	6,20	5,20	5,30	2,70	8,70
2SIE 200 LB	2	3,00	2,50	2,30	1,80	2,90	2SIE 315 MB	6	5,60	4,80	5,20	2,00	9,20
2SIE 200 L	4	3,70	3,10	2,80	2,00	3,90	2SIE 315 MC	2	2,80	2,50	2,70	0,60	5,40
2SIE 200 LA	6	4,30	3,60	3,60	2,90	4,60	2SIE 315 MC	4	6,30	5,30	4,30	1,10	8,50
2SIE 200 LB	6	4,20	3,50	3,60	2,80	4,60	2SIE 315 MC	6	7,50	6,30	5,10	1,80	9,20
							2SIE 315 MD	6	7,50	6,30	5,00	1,80	9,20

PERMISSIBLE LOADS ON THE SHAFT END

Value of radial force F_R acting on the shaft end for a given belt pulley diameter is calculated according to the following formula:

$$F_R = \frac{19600 \times P \times k}{D_k \times n} \text{ [N]}$$

- where: P - motor output [kW]
 D_k - belt pulley diameter [m]
 n - speed [rpm]
 k - belt tension factor:
 for V-belts k=2,2
 for flat belts k=3

Value of force F_R acting on any point of the shaft end (between points X=max and X=0) may be calculated according to the following formula:

$$F_R = F_{X0} - \frac{X}{E} \times (F_{X0} - F_{XMAX}) \text{ [N]}$$

- where: F_{X0} - value of F_R force acting on the beginning of the shaft end
 F_{XMAX} - value of F_R force acting on the end of the shaft end
 E - length of the shaft end

Other specifications dependent on the frame size:

Frame size	Degree of protection	Position of the terminal box	Number of terminals	Number of cable outlets	Optional rotation of the terminal box	Glands	Temperature sensors in winding	Bearing lubrication on the run	Thermal protection of bearings
80	IP 55	top	6	1	180°	M 20	on request	no	no
90	IP 55	top	6	2	180°	M 20	on request	no	no
100	IP 55	top	6	2	180°	M 20	on request	no	no
112	IP 55	top	6	2	180°	M 25	on request	no	no
132	IP 55	top	6	2	180°	M 25	on request	no	no
160	IP 55	top	6	2	180°	M 40	on request	on request	on request
180	IP 55	top	6	2	180°	M 40	on request	on request	on request
200	IP 55	top *	6	2	4 × 90°	M 50	PTC	yes	on request
225	IP 55	top *	6	2	4 × 90°	M 50	PTC	yes	on request
250	IP 55	top *	6	2	4 × 90°	M 63	PTC	yes	on request
280	IP 55	top *	6	2	4 × 90°	M 63	PTC	yes	on request
315	IP 55	top *	6	2	4 × 90°	M 76	PTC	yes	on request
355ML	IP 55	top	6	2	4 × 90°	M 76	PTC Mark A	yes	on request
355H	IP 55	top	6	2	4 × 90°	M 90	Pt 100	yes	Pt 100

BEARINGS

Frame size	Number of poles	Bearings
2SIE 80	2 ÷ 6	6204 2Z
2SIE 90	2 ÷ 6	6205 2Z C3
2SIE 100	2 ÷ 6	6206 2Z C3
2SIE 112	2 ÷ 6	6306 2Z C3
2SIE 132	2 ÷ 6	6308 2Z C3
2SIE 160	2 ÷ 6	6309 2Z C3
2SIE 180	2 ÷ 6	6311 2Z C3
2SIE 200	2 ÷ 6	6312 C3
2SIE 225	2 ÷ 6	6313 C3
2SIE 250	2 ÷ 6	6315 C3
2SIE 280	2	6315 C3
2SIE 280	4 ÷ 6	6318 C3
2SIE 315S, MA, MB	2	6315 C3
2SIE 315MC	2	6316 C3
2SIE 315S, MA, MB	4 ÷ 6	6318 C3
2SIE 315MC, MD	4 ÷ 6	6320C3/6318C3
SIE 315MC, MD	8	6320C3/6318C3

The bearings in basic version of motors for horizontal and vertical duty, excluding 3SIE 315 with 2p=2.

Frame Size	Type of construction	No. of poles, 2p	D.E. bearing	N.D.E. bearing
2SIE 315 ML	IM1001 (B3)	4 ÷ 6	6319 C3	6314 C3
2SIEL 315 ML	IM2001 (B35)	4 ÷ 6	6319 C3	6314 C3
2SIE 355 ML	IM1001 (B3)	2	6217 C3	6217 C3
2SIEL 355 ML	IM2001 (B35)	4 ÷ 6	6222 C3	6222 C3
2SIEK 355 ML	IM3011 (V1)	4 ÷ 6	6322 C3	6322 C3
2SIE 355 H	IM1001 (B3)	2	6217 C3	6217 C3
2SIEL 355 H	IM2001 (B35)	4 ÷ 6	6322 C3	6322 C3
2SIEK 355 H	IM3011 (V1)	4 ÷ 6	6322 C3	6322 C3

The bearings in basic version of motors for horizontal and vertical duty.

HOUSING, END SHIELDS, FEET

Frame size [mm]	Motor housing	End shields	Feet
80	Aluminium	Aluminium	Aluminium - screwed
90	Aluminium	Aluminium	Aluminium - screwed
100	Aluminium	Aluminium	Aluminium - screwed
112	Aluminium	Cast iron	Aluminium - screwed
132	Cast iron	Cast iron	Cast iron - screwed
160	Cast iron	Cast iron	Cast iron - integrated
180	Cast iron	Cast iron	Cast iron - integrated
200	Cast iron	Cast iron	Cast iron - integrated
225	Cast iron	Cast iron	Cast iron - integrated
250	Cast iron	Cast iron	Cast iron - integrated
280	Cast iron	Cast iron	Cast iron - integrated
315	Cast iron	Cast iron	Cast iron - screwed or integrated
355	Cast iron	Cast iron	Cast iron - integrated

In motors series 2SIE of frame size 80 and 90mm: on request end shields may be made of cast iron.
 In motors of frame size 132: feet may be integrated with housing.

Motor housing

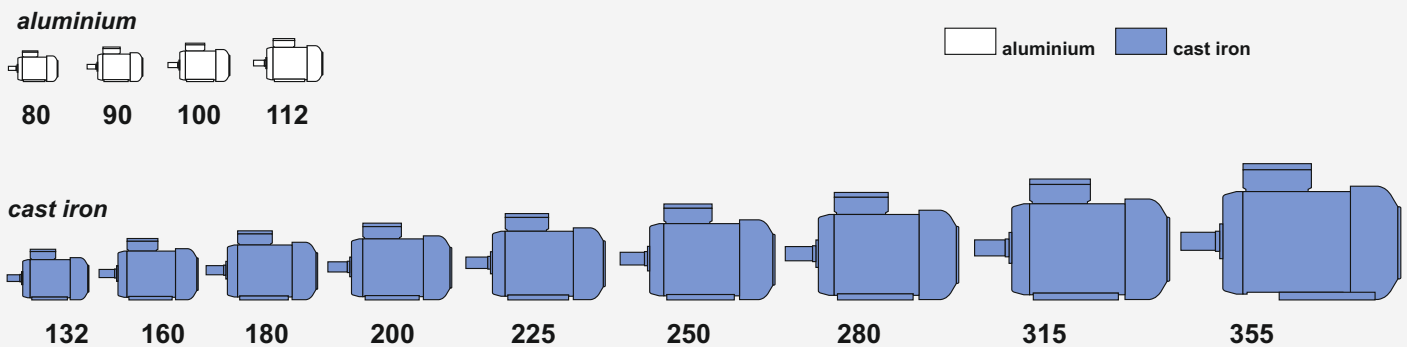

DESCRIPTION OF THE CATALOGUE VERSION

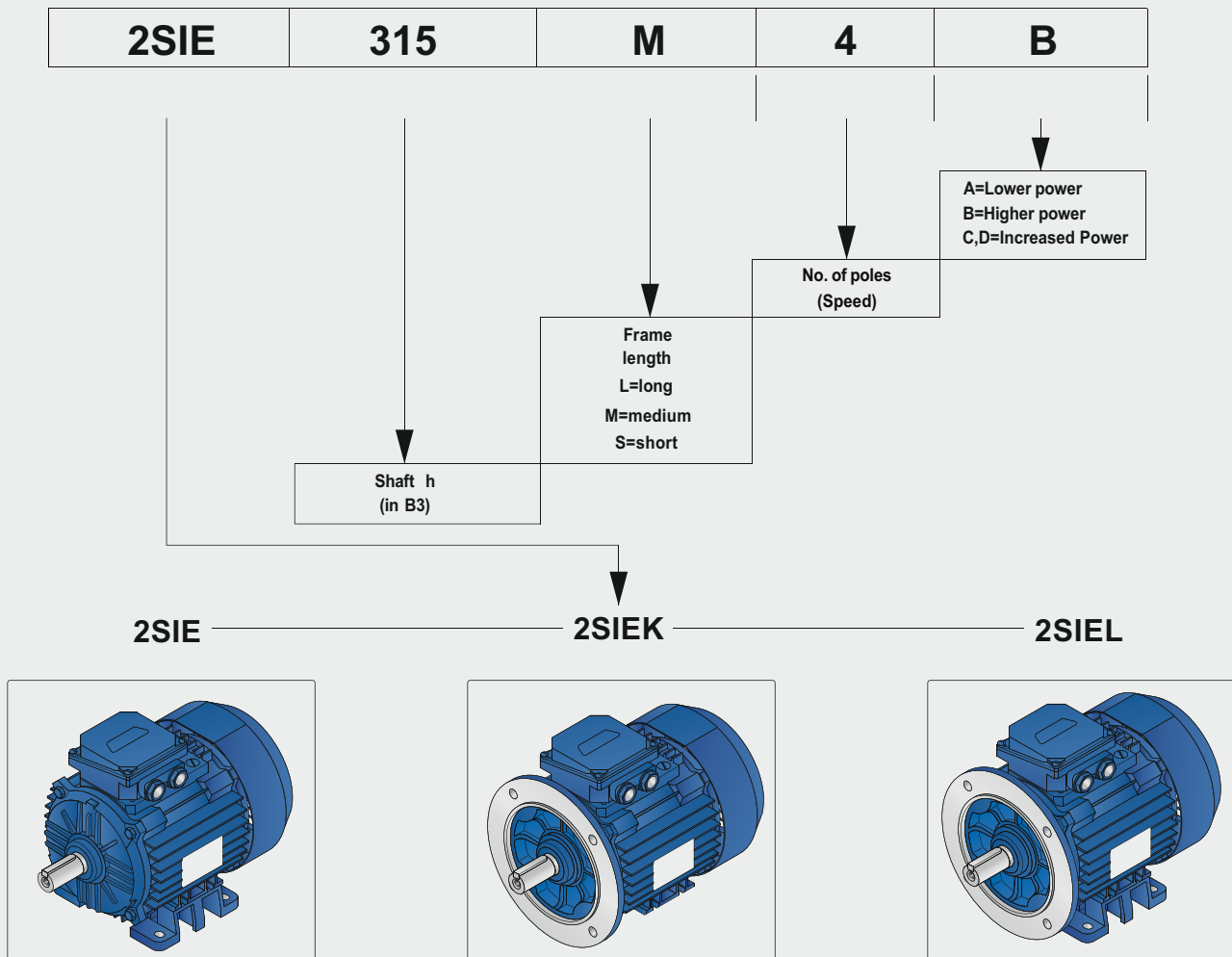

ORDERING INFORMATION

Orders for motors should specify:

- motor type designation,
- rated output,
- rated speed,
- operating duty,
- supply voltage and connection,
- frequency,
- mounting arrangements, end shield material,
- degree of protection,
- type of driven machine,
- other details regarding special requests,

and information concerning additional accessories e.g.

- thermal protection,
- anticondensation heaters,
- vibration sensors,
- etc.

When ordering high-power or special purpose motors one should also indicate:

- required direction of rotation,
- required degree of interior protection,
- method of start-up,
- method of coupling with the driven unit (gears, dimensions of belt pulleys, etc.),
- type of machine driven (nature of load), including the moment of inertia J or flywheel effect GD^2 brought to the motor shaft,
- other customer's specifications.

When ordering spare parts one should specify:

- full designation of the motor type including its serial number (provided on the nameplate) or catalogue number,
- degree of protection,
- mounting arrangement,
- name of part,
- number of pieces.

As part of our development program, we reserve the right to alter or amend any of the specifications without giving prior notice

Totally Enclosed Motors IP 55

Item	Type	Rated output		Rated speed	Rated torque	Efficiency			Power factor	Full load current			Locked rotor torque	Locked rotor current	Breakdown torque	Moment of Inertia	Weight	
		P_N				n_N	T_N	η_N [%]			I_N at rated voltage [A]							
		[kW]	[HP]	[min ⁻¹]	[Nm]	50%	75%	100%	cos ϕ_N	230V	380V	400V	T_L/T_N	I_L/I_N	T_B/T_N	J	[kgm ²]	[kg]
						$n_s=3000\text{ rpm}$				$f=50\text{ Hz}$								
						$2p=2$												
1	2SIE 80-2A	0,75	1	2840	2,52	72,0	76,5	79,0	0,74	3,3	2,0	1,9	3,2	5,0	3,0	0,0008	8,5	
2	2SIE 80-2B	1,1	1,5	2840	3,7	77,0	80,0	80,0	0,75	4,8	2,8	2,7	3,4	5,5	3,4	0,0011	9,8	
3	2SIE 90S2	1,5	2	2880	5	80,0	82,0	81,8	0,81	5,7	3,4	3,3	3,3	7,6	3,4	0,0014	13,9	
4	2SIE 90L2	2,2	3	2870	7,3	83,4	84,4	83,5	0,81	8,2	4,9	4,7	3,7	7,3	3,7	0,0016	17,3	
5	2SIE 100L2	3	4	2905	9,8	82,1	84,4	84,6	0,83	10,7	6,5	6,2	3,1	8,3	3,3	0,0039	23,0	
6	2SIE 112M2	4	5,5	2915	13,1	86,9	87,3	86,3	0,87	13,4	8,1	7,7	2,4	8,5	2,7	0,006	33,5	
7	2SIE 132S2A	5,5	7,5	2930	17,9	88,5	89,2	87,5	0,90	17,5	10,6	10,1	2,7	8,8	3,4	0,014	59,5	
8	2SIE 132S2B	7,5	10	2920	24,5	88,2	89,1	88,6	0,92	23,1	14,0	13,2	2,7	8,5	3,3	0,017	70,8	
9	2SIE 160M2A	11	15	2940	35,7	89,4	90,3	90,0	0,87	35,3	21,3	20,3	2,0	7,2	2,7	0,042	96	
10	2SIE 160M2B	15	20	2935	48,8	90,6	91,0	90,3	0,89	46,9	28,4	26,9	2,0	7,0	2,8	0,048	103	
11	2SIE 160L2	18,5	25	2935	60,2	92,2	92,3	91,5	0,91	55,8	33,8	32,1	2,3	7,7	2,9	0,059	118	
12	2SIE 180M2	22	30	2945	71,3	90,8	91,7	91,3	0,88	68,7	41,6	39,5	2,6	7,5	3,2	0,062	156	
13	2SIE 200L2A	30	40	2953	97	92,0	92,5	92,0	0,90	91	55	52	2,1	6,0	2,4	0,15	266	
14	2SIE 200L2B	37	50	2954	120	92,7	93,1	92,6	0,91	110	67	63	1,8	6,1	2,6	0,18	290	
15	2SIE 225M2	45	60	2970	145	93,5	94,0	93,8	0,88	137	83	79	2,0	6,6	2,6	0,26	380	
16	2SIE 250M2	55	75	2963	177	94,0	94,1	93,6	0,91	162	98	93	1,7	6,0	2,2	0,42	492	
17	2SIE 280S2	75	100	2978	241	93,4	94,1	94,0	0,91	220	133	127	1,7	6,7	2,4	0,76	655	
18	2SIE 280M2	90	125	2978	289	94,0	94,6	94,4	0,91	263	159	151	1,8	7,0	2,8	0,95	688	
19	2SIE 315S2	110	150	2978	353	94,5	94,9	94,6	0,92	317	192	182	1,9	6,9	2,9	0,98	860	
20	2SIE 315M2A	132	175	2979	423	94,8	95,1	94,9	0,92	380	230	218	2,1	7,8	3,0	1,15	925	
21	2SIE 315M2B	160	220	2980	513	94,9	95,4	95,2	0,92	459	278	264	2,4	8,8	3,4	1,40	1005	
22	2SIE 315M2C*	200	270	2979	641	95,5	95,6	95,4	0,93	-	342	325	2,3	8,1	3,1	1,74	1183	
23	2SIE 355ML2	200	270	2987	639	94,0	95,2	95,6	0,90	-	353	336	1,9	8,0	3,4	2,8	1600	
24	2SIE 355ML2A	250	340	2982	801	94,7	95,6	95,7	0,91	-	436	414	1,8	7,0	2,8	2,8	1600	
25	2SIE 355ML2B	315	430	2982	1009	95,0	95,7	95,7	0,91	-	550	522	1,9	7,3	3,0	3,0	1680	
26	2SIE 355H2D	355	480	2985	1136	94,7	95,5	95,7	0,91	-	619	588	1,7	7,4	2,7	4,9	2140	

* insulation class F/F

Totally Enclosed Motors IP 55

Item	Type	Rated output		Rated speed	Rated torque	Efficiency			Power factor	Full load current			Locked rotor torque	Locked rotor current	Breakdown torque	Moment of Inertia	Weight
		P _N				η _N [%]	I _N at rated voltage [A]										
		[kW]	[HP]	50%	75%		100%	cosφ _N	230V	380V	400V	T _L /T _N	I _L /I _N	T _B /T _N	J	[kg]	
				2p=4			n_s=1500 rpm			f=50Hz							
27	2SIE 80-4B	0,75	1	1400	5,12	70,0	77,0	80,0	0,65	3,7	2,3	2,2	3,1	4,2	3,2	0,00209	9,6
28	2SIE 90S4	1,1	1,5	1425	7,4	79,1	81,3	81,4	0,76	4,5	2,7	2,6	2,4	5,7	2,8	0,0029	16,3
29	2SIE 90L4	1,5	2	1425	10,1	81,2	83,2	82,8	0,76	6,0	3,6	3,4	2,6	6,2	2,9	0,0036	18
30	2SIE 100L4A	2,2	3	1440	14,6	84,6	85,5	84,7	0,83	7,9	4,8	4,5	2,4	7,3	2,8	0,007	25,5
31	2SIE 100L4B	3	4	1445	19,8	83,7	85,7	85,5	0,75	11,8	7,1	6,8	3,1	8,0	3,2	0,0076	27,5
32	2SIE 112M4	4	5,5	1450	26,3	86,9	87,7	87,0	0,79	14,6	8,8	8,4	2,0	6,7	2,9	0,0115	35,5
33	2SIE 132S4	5,5	7,5	1460	36	87,0	88,2	88,0	0,80	19,6	11,9	11,3	2,4	8,3	3,1	0,031	69
34	2SIE 132M4	7,5	10	1460	49,1	88,5	89,2	88,7	0,80	26,5	16,1	15,3	2,5	7,7	3,3	0,036	73,5
35	2SIE 160M4	11	15	1470	71,5	89,3	90,3	89,8	0,81	38,0	23,0	21,8	2,0	7,1	2,8	0,057	106
36	2SIE 160L4	15	20	1470	97,4	90,7	91,3	90,6	0,81	51,3	31,1	29,5	2,3	7,5	3,3	0,07	127
37	2SIE 180M4	18,5	25	1470	120,2	90,2	91,3	91,2	0,86	59,2	35,8	34,0	2,9	7,8	3,6	0,139	169
38	2SIE 180L4	22	30	1460	143,9	91,4	92,0	91,6	0,86	70,1	42,4	40,3	2,9	7,6	3,3	0,144	180
39	2SIE 200L4	30	40	1474	194	93,3	93,2	92,4	0,89	92	55	53	2,1	5,8	2,5	0,31	284
40	2SIE 225S4	37	50	1484	238	92,7	93,3	93,1	0,86	116	70	67	2,3	7,4	2,8	0,49	368
41	2SIE 225M4	45	60	1484	290	93,1	93,8	93,6	0,86	140	85	81	2,2	7,4	2,7	0,57	404
42	2SIE 250M4	55	75	1482	354	93,2	93,7	93,5	0,90	164	99	94	1,9	5,9	2,4	0,79	478
43	2SIE 280S4	75	100	1488	481	94,7	94,8	94,2	0,90	222	134	128	1,8	6,2	2,2	1,37	678
44	2SIE 280M4	90	125	1488	578	93,8	94,4	94,2	0,89	269	163	155	2,1	7,1	2,7	1,50	700
45	2SIE 315S4	110	150	1488	706	94,9	95,1	94,6	0,90	324	196	186	2,0	6,6	2,5	1,85	875
46	2SIE 315M4A	132	175	1487	848	95,5	95,5	95,0	0,91	383	232	220	1,9	6,7	2,4	2,25	957
47	2SIE 315M4B	160	220	1489	1026	95,3	95,5	95,2	0,90	469	284	270	2,7	8,3	3,0	2,59	1012
48	2SIE 315M4C	200	270	1486	1285	95,6	95,6	95,2	0,91	-	351	333	2,1	7,1	2,5	3,24	1198
49	2SIE 315ML4	200	270	1487	1285	95,1	95,8	95,7	0,87	-	365	347	2,3	7,2	2,4	3,3	1198
50	2SIE 355ML4	200	270	1490	1282	95,2	95,8	95,8	0,89	-	356	339	2,0	7,4	2,4	5,3	1680
51	2SIE 355ML4A	250	340	1489	1603	95,6	96,0	95,9	0,89	-	445	423	2,0	7,3	2,4	5,3	1680
52	2SIE 355ML4B	315	430	1489	2020	95,6	96,0	95,9	0,90	-	555	527	2,2	7,6	2,5	6,4	1810
53	2SIE 355H4D	355	480	1488	2278	95,7	96,0	95,9	0,88	-	639	607	1,6	6,5	2,2	7,8	2175

Totally Enclosed Motors IP 55

Item	Type	Rated output		Rated speed	Rated torque	Efficiency			Power factor	Full load current			Locked rotor torque	Locked rotor current	Breakdown torque	Moment of Inertia	Weight
		P _N				η _N	cosφ _N	I _N at rated voltage [A]									
		[kW]	[HP]	[min ⁻¹]	[Nm]			50%	75%	100%	230V	380V	400V	T _L /T _N	I _L /I _N	T _B /T _N	J
				2p=6		n_s=1000 rpm			f=50Hz								
54	2SIE 90S6	0,75	1	925	7,7	74,3	76,8	75,9	0,70	3,5	2,1	2,0	2,2	4,2	2,6	0,0028	16,5
55	2SIE 90L6	1,1	1,5	910	11,5	77,8	79,0	78,1	0,71	5,0	3,0	2,9	2,4	4,3	2,7	0,0032	18,2
56	2SIE 100L6	1,5	2	950	15,1	78,4	80,7	80,3	0,73	6,4	3,9	3,7	2,4	5,5	2,6	0,01	22
57	2SIE 112M6	2,2	3	955	22	82,0	83,1	82,3	0,75	8,9	5,4	5,1	2,3	5,9	2,7	0,0177	32
58	2SIE 132S6	3	4	950	30,2	83,1	84,3	83,3	0,79	11,4	6,9	6,6	2,0	5,5	2,7	0,025	50
59	2SIE 132M6A	4	5,5	950	40,2	85,5	85,9	84,6	0,79	15,0	9,1	8,6	2,4	6,3	2,8	0,032	62
60	2SIE 132M6B	5,5	7,5	950	55,3	86,5	86,8	86,0	0,81	19,8	12,0	11,4	2,6	6,6	3,1	0,04	72
61	2SIE 160M6	7,5	10	960	74,6	88,2	88,5	87,4	0,81	26,6	16,1	15,3	2,3	6,7	3,1	0,072	100
62	2SIE 160L6	11	15	960	109,4	89,3	89,6	88,7	0,82	38,0	23,0	21,8	2,5	7,1	3,1	0,096	125
63	2SIE 180L6	15	20	975	146,9	89,1	90,1	89,7	0,82	51,2	31,0	29,4	2,8	6,3	2,4	0,22	170
64	2SIE 200L6A	18,5	25	987	179	89,7	90,8	90,7	0,80	64	38,5	37	2,0	5,6	2,2	0,50	283
65	2SIE 200L6B	22	30	985	213	90,2	90,9	90,9	0,82	74	45	43	1,9	5,3	2,0	0,57	294
66	2SIE 225M6	30	40	988	290	91,7	92,2	91,9	0,83	99	60	57	1,8	5,9	2,2	0,82	379
67	2SIE 250M6	37	50	992	356	91,8	92,7	92,6	0,83	121	73	69	2,0	6,9	2,7	1,23	436
68	2SIE 280S6	45	60	991	434	92,8	93,5	93,1	0,82	148	90	85	2,3	6,2	2,1	1,52	633
69	2SIE 280M6	55	75	991	530	93,3	93,8	93,5	0,83	178	108	102	2,4	6,5	2,1	1,85	690
70	2SIE 315S6	75	100	991	723	94,4	94,7	94,2	0,84	238	144	137	2,5	6,7	2,5	2,39	895
71	2SIE 315M6A	90	125	991	867	94,9	95,0	94,5	0,84	285	172	164	2,6	6,9	2,2	2,81	953
72	2SIE 315M6B	110	150	991	1060	95,3	95,3	94,7	0,84	347	210	200	2,5	6,6	2,0	3,46	1106
73	2SIE 315M6C	132	175	990	1273	95,2	95,3	94,9	0,85	-	249	236	2,5	6,6	2,1	4,21	1226
74	2SIE 315M6D	160	220	990	1543	95,3	95,4	95,0	0,83	-	308	293	2,8	7,2	2,4	4,36	1233
75	2SIE 315ML6	160	220	987	1548	94,4	95,0	94,8	0,84	-	305	290	2,1	6,3	2,4	3,5	1240
76	2SIE 355ML6A	200	270	989	1931	95,1	95,6	95,5	0,86	-	370	351	2,1	7,0	2,4	7,2	1720
77	2SIE 355ML6B	250	340	990	2412	95,5	95,9	95,7	0,86	-	462	438	2,2	7,1	2,4	8,6	1920
78	2SIE 355H6C	315	430	992	3033	95,6	95,9	95,7	0,86	-	582	552	1,9	7,0	2,2	12,7	2370
79	2SIE 355H6D	355	480	991	3421	95,5	95,9	95,7	0,86	-	655	623	1,8	6,9	2,3	13,6	2480

Dimensions for FOOT MOUNTED MOTORS - IM B3

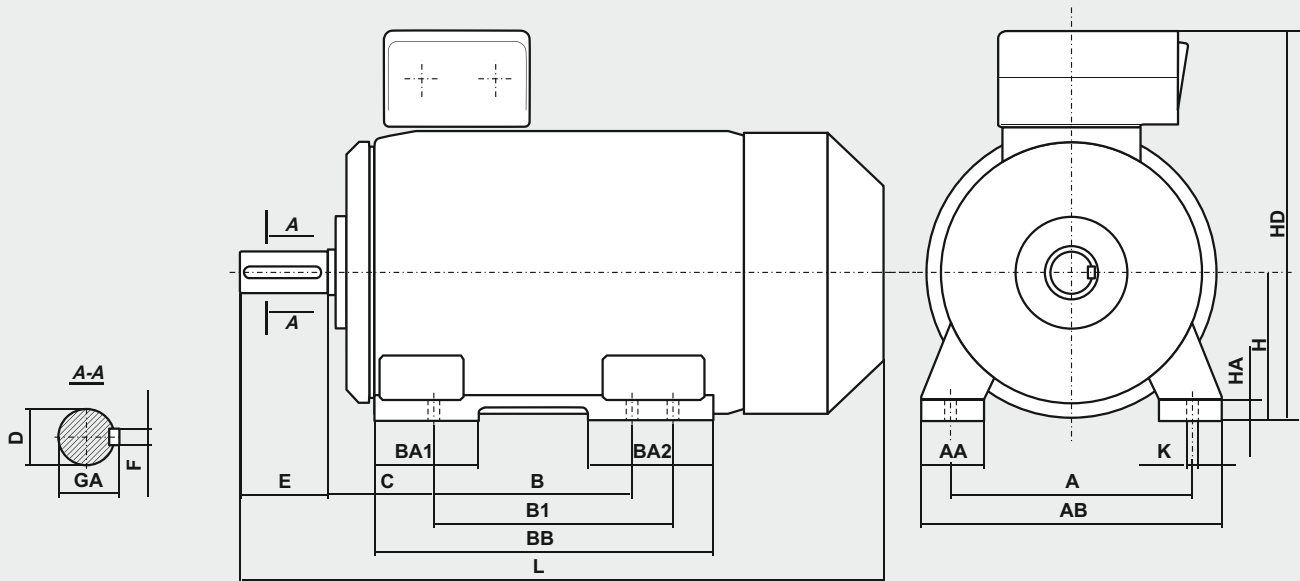

Motor type	A	B	B1	C	D	E	F	GA	H	HA	K	AA	AB	BA1	BA2	BB	HD	L
2SIE200	318	305	-	133	55	110	16	59	200	32	19	80	400	113	113	380	520	850
2SIE225S4	356	286	311	149	60	140	18	64	225	34	19	85	440	115	115	380	570	930
2SIE225M2	356	286	311	149	55	110	16	59	225	34	19	85	440	115	115	380	570	900
2SIE225M4-6	356	286	311	149	60	140	18	64	225	34	19	85	440	115	115	380	570	930
2SIE250M2	406	349	-	168	60	140	18	64	250	37	24	90	480	135	135	445	635	1010
2SIE250M4-6	406	349	-	168	65	140	18	69	250	37	24	90	480	135	135	445	635	1040
2SIE280S2	457	368	419	190	65	140	18	69	280	40	24	105	550	130	165	520	720	1135
2SIE280S4-6	457	368	419	190	75	140	20	79,5	280	40	24	105	550	130	165	520	720	1135
2SIE280M2	457	368	419	190	65	140	18	69	280	40	24	105	550	130	165	520	720	1135
2SIE280M4-6	457	368	419	190	75	140	20	79,5	280	40	24	105	550	130	165	520	720	1135
2SIE315S2	508	406	457	216	65	140	18	69	315	48	28	120	610	160	160	565	805	1235
2SIE315S4-6	508	406	457	216	80	170	22	85	315	48	28	120	610	160	160	565	805	1265
2SIE315M2A;B	508	406	457	216	65	140	18	69	315	48	28	120	610	160	160	565	805	1235
2SIE315M4A;B;6A	508	406	457	216	80	170	22	85	315	48	28	120	610	160	160	565	805	1265
2SIE315M6B	508	406	457	216	80	170	22	85	315	48	28	135	610	135	205	600	805	1355
2SIE315M2C	508	406	457	216	70	140	20	74,5	315	48	28	135	610	135	205	600	805	1290
2SIE315M4C	508	406	457	216	80	170	22	85	315	48	28	135	610	135	205	600	805	1320
2SIE315M6C	508	406	457	216	80	170	22	85	315	48	28	135	610	135	205	600	805	1320
2SIE315M6D	508	406	457	216	90	170	25	95	315	48	28	135	610	135	205	600	805	1320
2SIE 315 ML (4, 6)	508	457	508	216	80	170	22	85	315	40	28	120	620	150	180	637	865	1345
2SIE 355 ML (2)	610	560	630	254	80	170	22	85	355	50	28	150	720	250	300	890	935	1580
2SIE 355 ML (4, 6)	610	560	630	254	100	210	28	106	355	50	28	150	720	250	300	890	935	1620
2SIE 355 H (2)	610	900	-	200	70	140	20	74,5	355	45	28	160	730	265	265	1045	995	1800
2SIE 355 H (4, 6)	610	900	-	200	100	210	28	106	355	45	28	160	730	265	265	1045	995	1870

Dimensions for FOOT MOUNTED MOTORS - IM B3

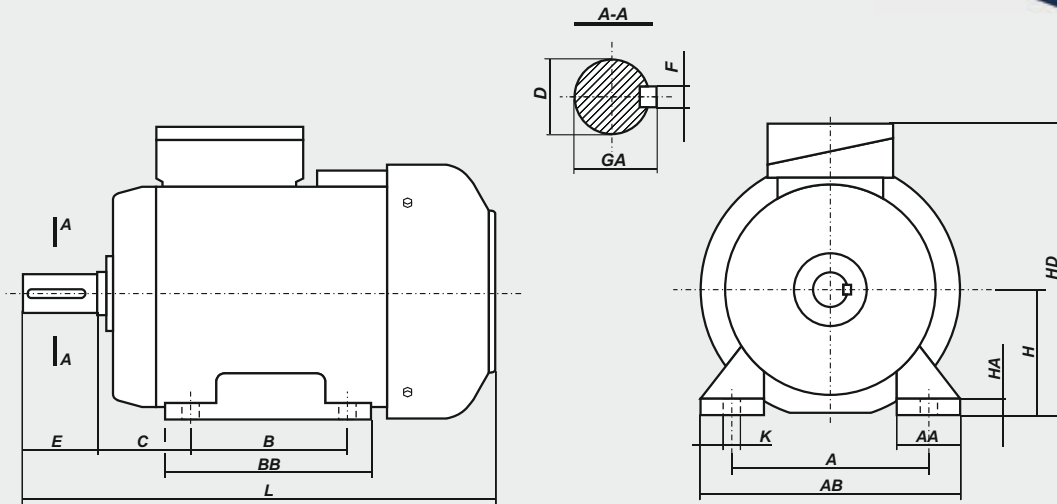

Motor type	A	B	C	D	E	F	GA	H	K	AA	AB	BB	HA	HD	L
2SIE 80-.A	125	100	50	19j6	40	6h9	21,5	80	10	55	160	130	9	200	266
2SIE 80-.B	125	100	50	19j6	40	6h9	21,5	80	10	55	160	130	9	200	278
2SIE 90S-2,4,6	140	100	56	24j6	50	8h9	27	90	10	41	170	153	10	228	331
2SIE 90L-2	140	125	56	24j6	50	8h9	27	90	10	41	170	153	10	228	331
2SIE 90L-4,6	140	125	56	24j6	50	8h9	27	90	10	41	170	153	10	228	356
2SIE 100L-2,6	160	140	63	28j6	60	8h9	31	100	12	44	197	174	14	250	377
2SIE 100L-4A,4B	160	140	63	28j6	60	8h9	31	100	12	44	197	174	14	250	421
2SIE 112M-2,6	190	140	70	28j6	60	8h9	31	112	12	49	230	174	14	276	389
2SIE 112M-4	190	140	70	28j6	60	8h9	31	112	12	49	230	174	14	276	416
2SIE 132S-2A,6	216	140	89	38k6	80	10h9	41	132	12	62	274	182	17	310	461
2SIE 132S-2B,4	216	140	89	38k6	80	10h9	41	132	12	62	274	182	17	310	499
2SIE 132M-4,6A,6B	216	178	89	38k6	80	10h9	41	132	12	62	274	220	17	310	499
2SIE 160M-2A,2B,4,6	254	210	108	42k6	110	12h9	45	160	15	60	305	256	22	365	611
2SIE 160L-2,4,6	254	254	108	42k6	110	12h9	45	160	15	60	305	300	22	365	655
2SIE 180M-2,4	279	241	121	48k6	110	14h9	51,5	180	15	70	350	315	23	403	701
2SIE 180L-4,6	279	279	121	48k6	110	14h9	51,5	180	15	70	350	315	23	403	701

Dimensions for FLANGE MOUNTED MOTORS - IM B5, IM V1

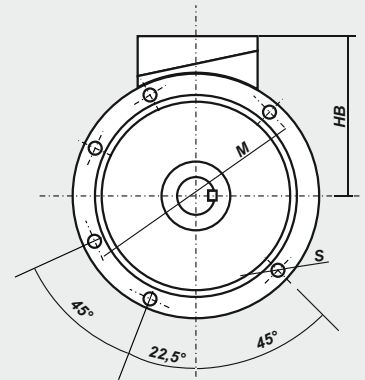
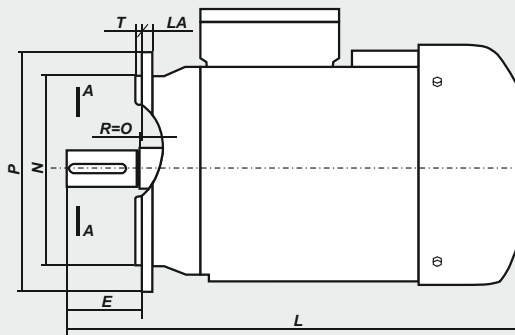
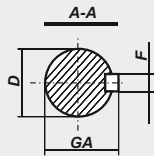

Motor type	D	E	F	GA	M	N	P	LA	T	HB	L	S (f)	S (holes)
2SIEK 80-.A	19j6	40	6h9	21,5	165	130j6	200	10	3,5	120	266	12	4
2SIEK 80-.B	19j6	40	6h9	21,5	165	130j6	200	10	3,5	120	278	12	4
2SIEK 90S-2,4,6	24j6	50	8h9	27	165	130j6	200	8	3,5	139	331	12	4
2SIEK 90L-2	24j6	50	8h9	27	165	130j6	200	8	3,5	139	331	12	4
2SIEK 90L-4,6	24j6	50	8h9	27	165	130j6	200	8	3,5	139	356	12	4
2SIEK 100L-2,6	28j6	60	8h9	31	215	180j6	250	11	4	150	377	15	4
2SIEK 100L-4A,4B	28j6	60	8h9	31	215	180j6	250	11	4	150	421	15	4
2SIEK 112M-2,6	28j6	60	8h9	31	215	180j6	250	12	4	165	385	15	4
2SIEK 112M-4	28j6	60	8h9	31	215	180j6	250	12	4	165	416	15	4
2SIEK 132S-2A,6	38k6	80	10h9	41	265	230j6	300	12	4	178	461	15	4
2SIEK 132S-2B,4	38k6	80	10h9	41	265	230j6	300	12	4	178	499	15	4
2SIEK 132M-4,6A,6B	38k6	80	10h9	41	265	230j6	300	12	4	178	499	15	4
2SIEK 160M-2A,2B,4,6	42k6	110	12h9	45	300	250j6	350	13	5	205	611	19	4
2SIEK 160L-2,4,6	42k6	110	12h9	45	300	250j6	350	13	5	205	655	19	4
2SIEK 180M-2,4	48k6	110	14h9	51,5	300	250j6	350	13	5	224	701	19	4
2SIEK 180L-4,6	48k6	110	14h9	51,5	300	250j6	350	13	5	224	701	19	4
2SIEK 200	55	110	16	59	350	300	400	16,5	5	320	850	19	4
2SIEK 225S4	60	140	18	64	400	350	450	18	5	345	930	19	8
2SIEK 225M2	55	110	16	59	400	350	450	18	5	345	900	19	8
2SIEK 225M4-6	60	140	18	64	400	350	450	18	5	345	930	19	8
2SIEK 250M2	60	140	18	64	500	450	550	23	5	385	1010	19	8
2SIEK 250M4-6	65	140	18	69	500	450	550	23	5	385	1040	19	8
2SIEK 280S2	65	140	18	69	500	450	550	23	5	440	1135	19	8
2SIEK 280S4-6	75	140	20	79,5	500	450	550	23	5	440	1135	19	8
2SIEK 280M2	65	140	18	69	500	450	550	23	5	440	1135	19	8
2SIEK 280M4-6	75	140	20	79,5	500	450	550	23	5	440	1135	19	8
2SIEK 315S2	65	140	18	69	600	550	660	23	6	490	1235	24	8
2SIEK 315S4-6	80	170	22	85	600	550	660	23	6	490	1265	24	8
2SIEK 315M2A;B	65	140	18	69	600	550	660	23	6	490	1235	24	8
2SIEK 315M4A;B;6A	80	170	22	85	600	550	660	23	6	490	1265	24	8
2SIEK 315M6B*	80	170	22	85	600	550	660	23	6	490	1355	24	8
2SIEK 315M2C*	70	140	20	74,5	600	550	660	23	6	490	1290	24	8
2SIEK 315M4C*	80	170	22	85	600	550	660	23	6	490	1320	24	8
2SIEK 315M6C*	80	170	22	85	600	550	660	23	6	490	1320	24	8
2SIEK 315M6D*	90	170	22	95	600	550	660	23	6	490	1320	24	8
2SIEK 355 ML (4 - 6)*	100m6	210	28h9	106	740	680	800	24	6	580	1620	22	8
2SIEK 355 H (4 - 6)*	100m6	210	28h9	106	740	680	800	24	6	638	1955	22	8

* only in vertical position IM V1

Dimensions for FOOT/FLANGE MOUNTED MOTORS - IM B35

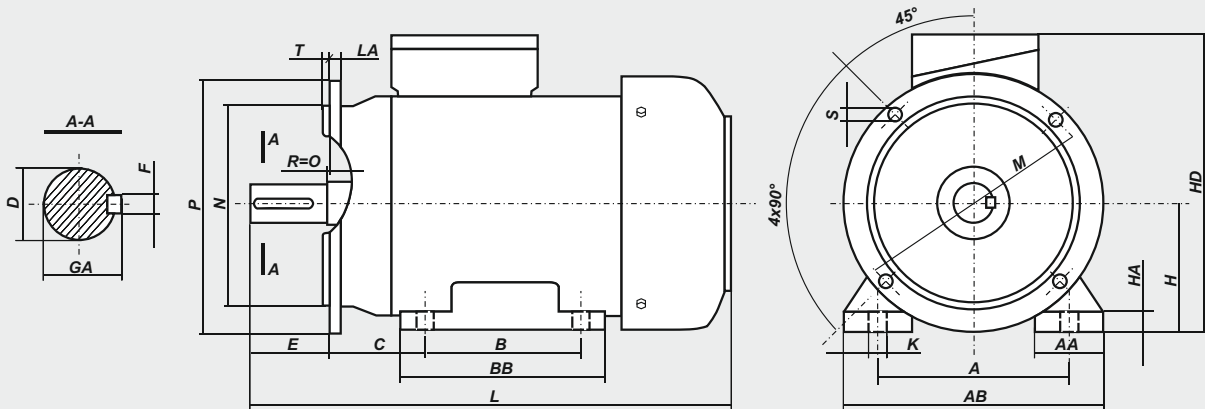

Motor type	A	B	C	D	E	F	GA	H	K	M	N	P	S	LA	T	AA	AB	BB	HA	HD	L
2SIEL 80-.A	125	100	50	19j6	40	6h9	21,5	80	10	165	130j6	200	12	10	3,5	55	160	130	9	200	266
2SIEL 80-.B	125	100	50	19j6	40	6h9	21,5	80	10	165	130j6	200	12	10	3,5	55	160	130	9	200	278
2SIEL 90S-2,4,6	140	100	56	24j6	50	8h9	27	90	10	165	130j6	200	12	8	3,5	41	170	153	10	228	331
2SIEL 90L-2	140	125	56	24j6	50	8h9	27	90	10	165	130j6	200	12	8	3,5	41	170	153	10	228	331
2SIEL 90L-4,6	140	125	56	24j6	50	8h9	27	90	10	165	130j6	200	12	8	3,5	41	170	153	10	228	356
2SIEL 100L-2,6	160	140	63	28j6	60	8h9	31	100	12	215	180j6	250	15	11	4	44	197	174	14	250	377
2SIEL 100L-4A,4B	160	140	63	28j6	60	8h9	31	100	12	215	180j6	250	15	11	4	44	197	174	14	250	421
2SIEL 112M-2,6	190	140	70	28j6	60	8h9	31	112	12	215	180j6	250	15	12	4	49	230	174	14	276	389
2SIEL 112M-4	190	140	70	28j6	60	8h9	31	112	12	215	180j6	250	15	12	4	49	230	174	14	276	416
2SIEL 132S-2A,6	216	140	89	38k6	80	10h9	41	132	12	265	230j6	300	15	12	4	62	274	182	17	310	461
2SIEL 132S-2B,4	216	140	89	38k6	80	10h9	41	132	12	265	230j6	300	15	12	4	62	274	182	17	310	499
2SIEL 132M-4,6A,6B	216	178	89	38k6	80	10h9	41	132	12	265	230j6	300	15	12	4	62	274	220	17	310	499
2SIEL 160M-2A,2B,4,6	254	210	108	42k6	110	12h9	45	160	15	300	250j6	350	19	13	5	60	305	256	22	370	611
2SIEL 160L-2,4,6	254	254	108	42k6	110	12h9	45	160	15	300	250j6	350	19	13	5	60	305	300	22	370	655
2SIEL 180M-2,4	279	241	121	48k6	110	14h9	51,5	180	15	300	250j6	350	19	13	5	70	350	315	23	408	701
2SIEL 180L-4,6	279	279	121	48k6	110	14h9	51,5	180	15	300	250j6	350	19	13	5	70	350	315	23	408	701

Dimensions for FOOT/FLANGE MOUNTED MOTORS - IM B35

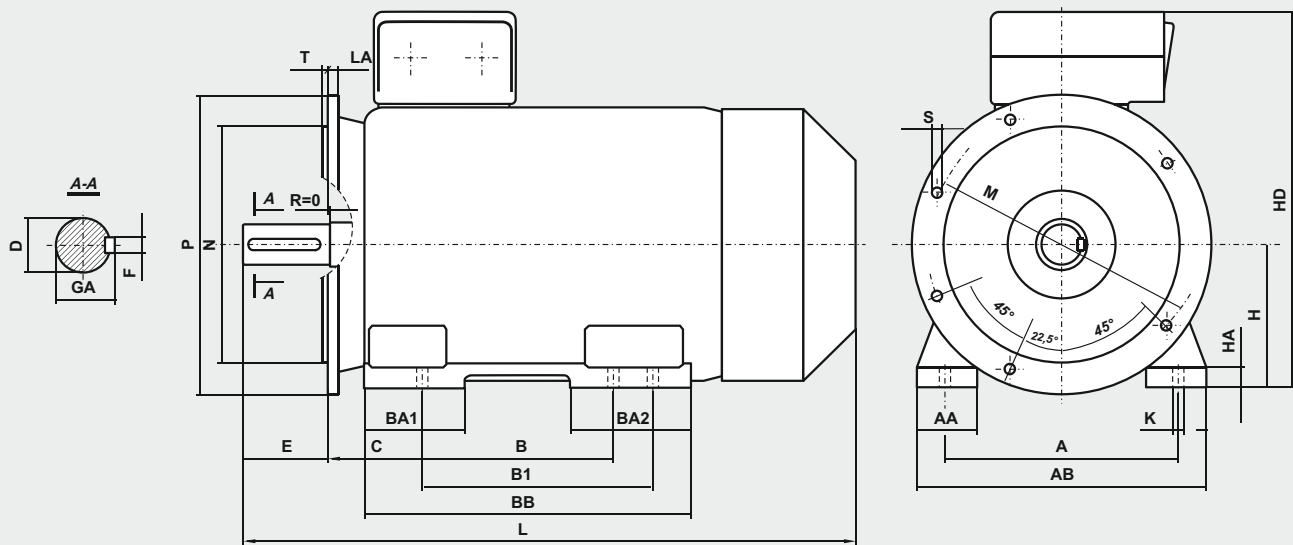

Motor type	A	B	B1	C	D	E	F	GA	H	HA	K	AA	AB	BA1	BA2	BB	HD	LA	P	M	N	T	L	S (φ)	S (holes)
2SIEL 200	318	305	-	133	55	110	16	59	200	32	19	80	400	113	113	380	520	16,5	400	350	300	5	850	19	4
2SIEL 225S4	356	286	311	149	60	140	18	64	225	34	19	85	440	115	115	380	570	18	450	400	350	5	930	19	8
2SIEL 225M2	356	286	311	149	55	110	16	59	225	34	19	85	440	115	115	380	570	18	450	400	350	5	900	19	8
2SIEL 225M4-6	356	286	311	149	60	140	18	64	225	34	19	85	440	115	115	380	570	18	450	400	350	5	930	19	8
2SIEL 250M2	406	349	-	168	60	140	18	64	250	37	24	90	480	135	135	445	635	23	550	500	450	5	1010	19	8
2SIEL 250M4-6	406	349	-	168	65	140	18	69	250	37	24	90	480	135	135	445	635	23	550	500	450	5	1040	19	8
2SIEL 280S2	457	368	419	190	65	140	18	69	280	40	24	105	550	130	165	520	720	23	550	500	450	5	1135	19	8
2SIEL 280S4-6	457	368	419	190	75	140	20	79,5	280	40	24	105	550	130	165	520	720	23	550	500	450	5	1135	19	8
2SIEL 280M2	457	368	419	190	65	140	18	69	280	40	24	105	550	130	165	520	720	23	550	500	450	5	1135	19	8
2SIEL 280M4-6	457	368	419	190	75	140	20	79,5	280	40	24	105	550	130	165	520	720	23	550	500	450	5	1135	19	8
2SIEL 315S2	508	406	457	216	65	140	18	69	315	48	28	120	610	160	160	565	805	23	660	600	550	6	1235	24	8
2SIEL 315S4-6	508	406	457	216	80	170	22	85	315	48	28	120	610	160	160	565	805	23	660	600	550	6	1265	24	8
2SIEL 315M2A;B	508	406	457	216	65	140	18	69	315	48	28	120	610	160	160	565	805	23	660	600	550	6	1235	24	8
2SIEL 315M4A;B;6A	508	406	457	216	80	170	22	85	315	48	28	120	610	160	160	565	805	23	660	600	550	6	1265	24	8
2SIEL 315M6B	508	406	457	216	80	170	22	85	315	48	28	135	610	135	205	600	805	23	660	600	550	6	1355	24	8
2SIEL 315M2C	508	406	457	216	70	140	20	74,5	315	48	28	135	610	135	205	600	805	23	660	600	550	6	1290	24	8
2SIEL 315M4C	508	406	457	216	80	170	22	85	315	48	28	135	610	135	205	600	805	23	660	600	550	6	1320	24	8
2SIEL 315M6C	508	406	457	216	80	170	22	85	315	48	28	135	610	135	205	600	805	23	660	600	550	6	1320	24	8
2SIEL 315M6D;8C;8D	508	406	457	216	90	170	25	95	315	48	28	135	610	135	205	600	805	23	660	600	550	6	1320	24	8
2SIEL 315 ML (4,6)	508	457	508	216	80	170	22	85	315	40	28	120	620	150	180	637	865	22	660	600	550	6	1345	22	8
2SIEL 355 ML (2)	610	560	630	254	80	170	22	85	355	50	28	150	720	250	300	890	935	24	800	740	680	6	1580	22	8
2SIEL 355 ML (4,6)	610	560	630	254	100	210	28	106	355	50	28	150	720	250	300	890	935	24	800	740	680	6	1620	22	8
2SIEL 355 H (2)	610	900	-	254	70	140	20	74,5	355	45	28	160	730	265	265	1045	995	24	800	740	680	6	1854	22	8
2SIEL 355 H (4,6)	610	900	-	254	100	210	28	106	355	45	28	160	730	265	265	1045	995	24	800	740	680	6	1924	22	8

Dimensions for FLANGE MOUNTED MOTORS - IM B14

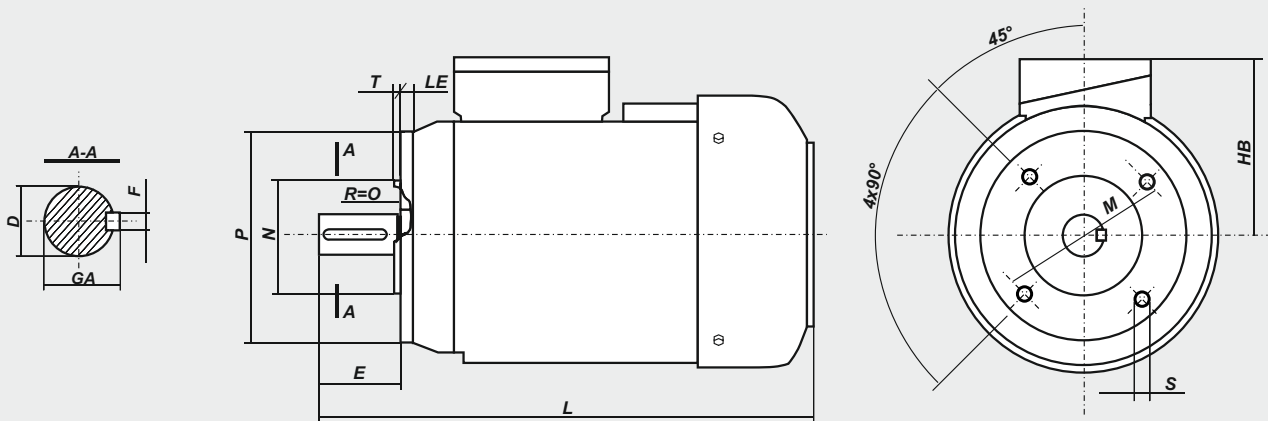

Motor type	Flange	D	E	F	GA	M	N	P	S	T	LE	HB	L
2SIEK 80- .A1	B14/C1	19j6	40	6h9	21,5	130	110j6	160	M8	3,5	14	120	266
2SIEK 80- .A2	B14/C2	19j6	40	6h9	21,5	100	80j6	120	M6	3	12	120	266
2SIEK 80- .B1	B14/C1	19j6	40	6h9	21,5	130	110j6	160	M8	3,5	14	120	278
2SIEK 80- .B2	B14/C2	19j6	40	6h9	21,5	100	80j6	120	M6	3	12	120	278
2SIEK 90S 2,4,6	B14/C1	24j6	50	8h9	27	130	110j6	160	M8	3,5	10	139	331
2SIEK 90S 2,4,6	B14/C2	24j6	50	8h9	27	115	95j6	140	M8	3	10	139	331
2SIEK 90L 2	B14/C1	24j6	50	8h9	27	130	110j6	160	M8	3,5	10	139	331
2SIEK 90L 2	B14/C2	24j6	50	8h9	27	115	95j6	140	M8	3	10	139	331
2SIEK 90L 4,6	B14/C1	24j6	50	8h9	27	130	110j6	160	M8	3,5	10	139	356
2SIEK 90L 4,6	B14/C2	24j6	50	8h9	27	115	95j6	140	M8	3	10	139	356
2SIEK 100L2,6	B14/C1	28j6	60	8h9	31	165	130j6	200	M10	3,5	12	150	377
2SIEK 100L2,6	B14/C2	28j6	60	8h9	31	130	110j6	160	M8	3,5	12	150	377
2SIEK 100L4A,4B	B14/C1	28j6	60	8h9	31	165	130j6	200	M10	3,5	12	150	421
2SIEK 100L4A,4B	B14/C2	28j6	60	8h9	31	130	110j6	160	M8	3,5	12	150	421
2SIEK 112M2,6	B14/C1	28j6	60	8h9	31	165	130j6	200	M10	3,5	12	165	389
2SIEK 112M2,6	B14/C2	28j6	60	8h9	31	130	110j6	160	M8	3,5	12	165	389
2SIEK 112M4	B14/C1	28j6	60	8h9	31	165	130j6	200	M10	3,5	12	165	416
2SIEK 112M4	B14/C2	28j6	60	8h9	31	130	110j6	160	M8	3,5	12	165	416
2SIEK 132S2A,6	B14/C1	38k6	80	10h9	41	215	180j6	250	M12	4	12	178	461
2SIEK 132S2A,6	B14/C2	38k6	80	10h9	41	165	130j6	200	M10	3,5	12	178	461
2SIEK 132S2B,4	B14/C1	38k6	80	10h9	41	215	180j6	250	M12	4	12	178	499
2SIEK 132S2B,4	B14/C2	38k6	80	10h9	41	165	130j6	200	M10	3,5	12	178	499
2SIEK 132M4,6A,6B	B14/C1	38k6	80	10h9	41	215	180j6	250	M12	4	12	178	499
2SIEK 132M4,6A,6B	B14/C2	38k6	80	10h9	41	165	130j6	200	M10	3,5	12	178	499

List of Motor parts

Frame Size: 80

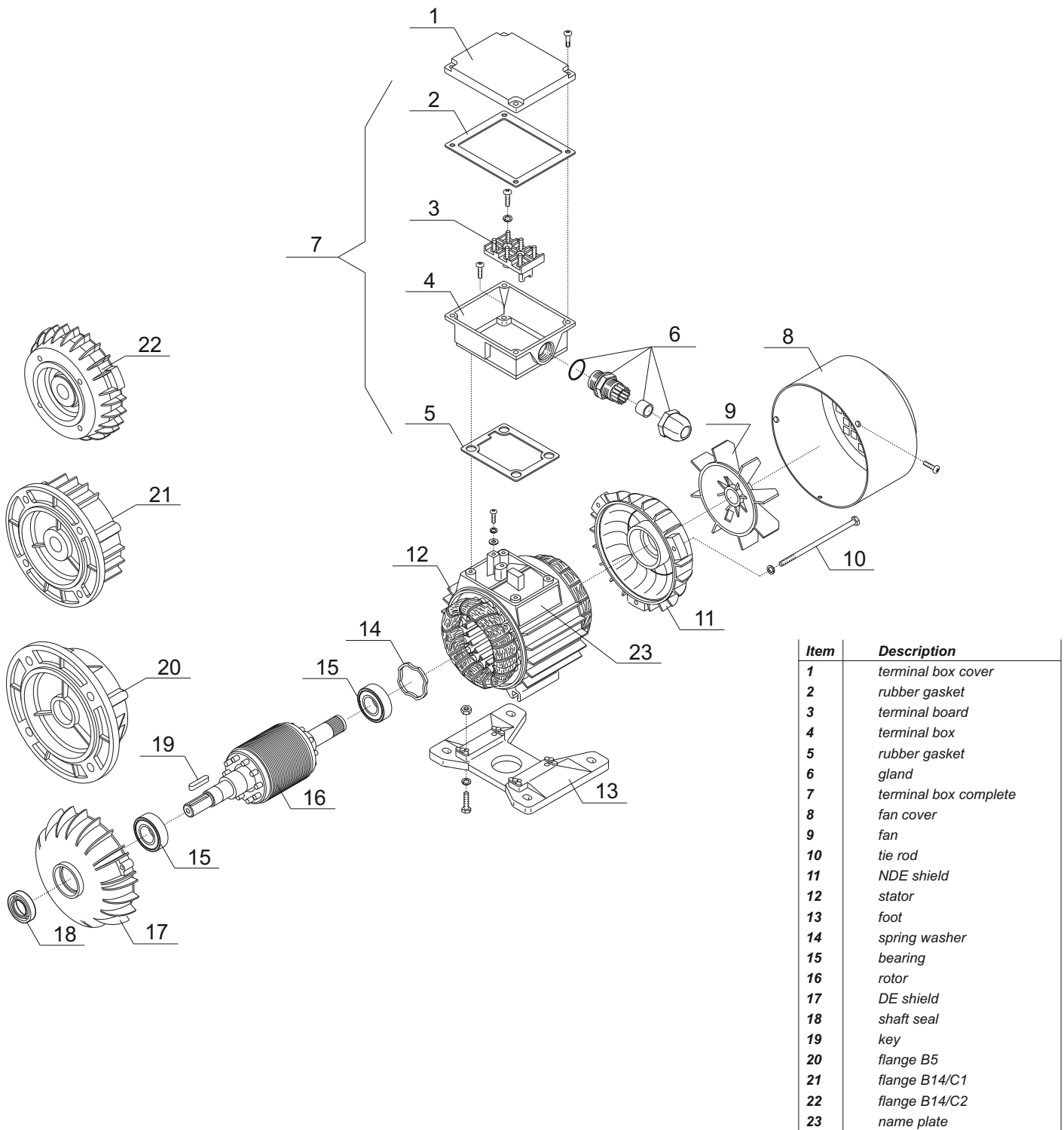

Item	Description
1	terminal box cover
2	rubber gasket
3	terminal board
4	terminal box
5	rubber gasket
6	gland
7	terminal box complete
8	fan cover
9	fan
10	tie rod
11	NDE shield
12	stator
13	foot
14	spring washer
15	bearing
16	rotor
17	DE shield
18	shaft seal
19	key
20	flange B5
21	flange B14/C1
22	flange B14/C2
23	name plate

DE - drive end
NDE - non drive end

Frame Size: 90 ÷ 180
Motor series 2SIE

List of Motor parts

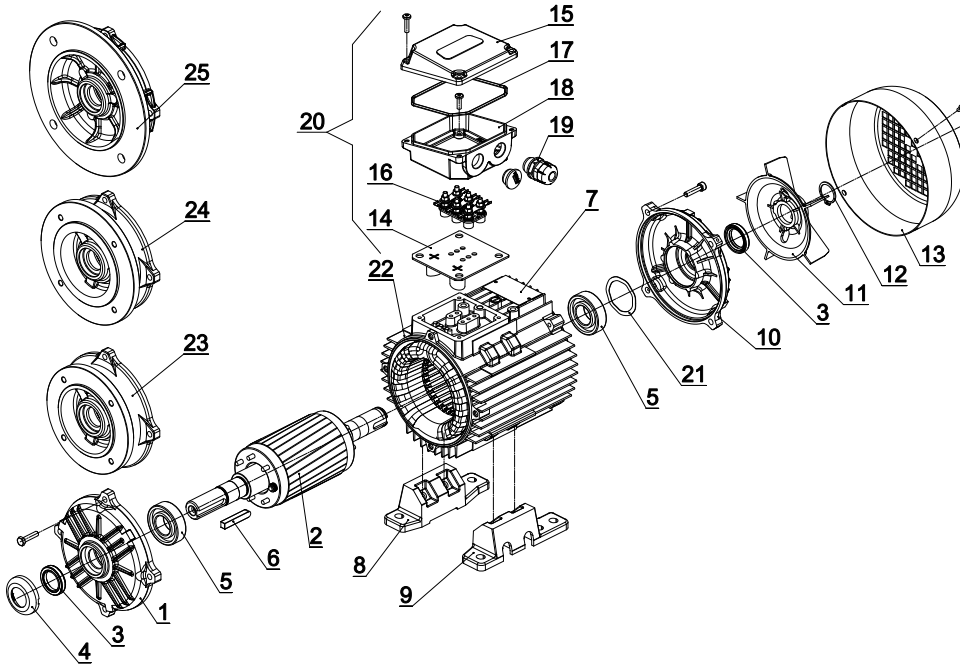

Item	Description
1	DE shield
2	rotor
3	shaft seal
4	shaft seal cover
5	bearing
6	key
7	name plate
8'	sx foot
9'	dx foot
10	NDE shield
11	fan
12	seeger ring
13	fan cover
14	rubber gasket
15	terminal box cover
16	terminal board
17	rubber gasket
18	terminal box
19	glands
20	terminal box complete
21	spring washer
22	stator
23 ²	flange B14/C2
24 ²	flange B14/C1
25	flange B5

1 - for frame size 132 - 180 feet can be screwed or integrated with the motor housing,
2 - only for frame size 90 - 132.





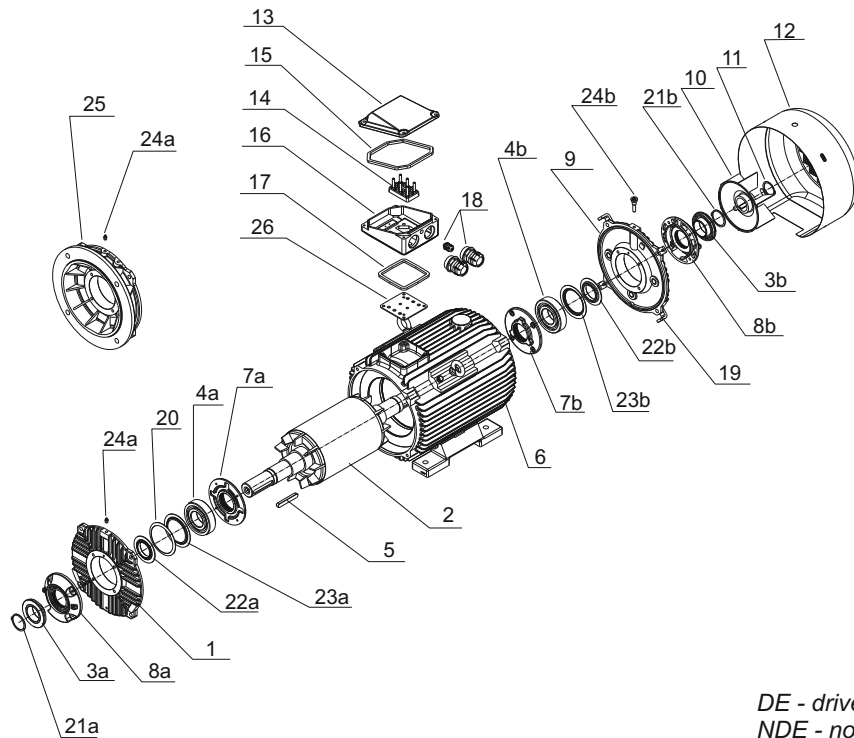

Item	Description
1	DE shield
2	rotor
3a,b	shaft seal
4a,b	bearing
5	key
6	housing with feet
7a,b	internal bearing cap
8a,b	external bearing cap
9	NDE shield
10	fan
11	seeger ring
12	fan cover
13	terminal box cover
14	terminal board
15	rubber gasket
16	terminal box housing
17	rubber gasket
18	cable glands
19	fan cover support
20	spring washer
21a,b	seeger ring
22a,b	grease shield
23a,b	bearing internal ring
24a,b	grease nipple
25	flange B5
26	rubber gasket

Frame Size: 200 ÷ 355
Motor series 2SIE











DE - drive end
NDE - non drive end

PRODUCT RANGE

GENERAL PURPOSE 3-PHASE INDUCTION MOTORS	Three-phase motors with squirrel-cage rotor series (2)Sg(m), Sh. High efficiency motors series 2SIE, 3SIE and 4SIE (Efficiency classes IE1, IE2, IE3, IE4)	from 0,04kW up to 1400kW	general purpose, pumps, fans, compressors, specific requirements relating to the highest efficiency	
GENERAL PURPOSE 1-PHASE INDUCTION MOTORS	Single-phase motors with squirrel-cage rotor series SEh(R), SEMh(R). - motors with standard starting torque - motors with increased starting torque - motors with high starting torque.	from 0,04kW up to 4kW	general purpose, pumps, fans, compressors, wood machines, machines and devices for food processing, mixers for building	
HIGH VOLTAGE INDUCTION MOTORS	Three-phase squirrel-cage high voltage and high efficiency motors series Sh with cast-iron housing. High voltage motors with module construction (steel/welded housing) series Sf-E and Sfw.	from 160kW up to 3150kW	general industrial use, drives used for own needs of power plants (pumps, fans, coal mills, conveyors)	
BRAKE MOTORS	Three-phase and single-phase brake motors with AC and DC brakes.	from 0,04kW up to 160kW	applied in case of necessity to stop the motor suddenly	
MOTORS WITH FOREIGN COOLING	Three-phase 3-phase induction motors with foreign cooling.	from 0,06kW up to 250kW	drives adapted for speed regulation by frequency converter	
EXPLOSION-PROOF MOTORS	Increased safety motors. Flame-proof motors.	from 0,06kW up to 22kW from 0,75kW up to 315kW	adapted for operation in areas endangered by explosion (without methane) application in an atmosphere where a mixture of explosive gas and vapours may occur	
NEMA MOTORS	Low voltage NEMA motors SIE series (in compliance with the NEMA PREMIUM requirements).	from 1HP up to 250HP	general industrial application, pumps, fans	
TRACTION MOTORS	Traction motors and traction generators.	from 50kW up to 1500kW	various traction vehicles: trams (including low-deck trams), trolleybuses, subway and locomotives	

PRODUCT RANGE

SUBMERSIBLE MOTORS	Submersible motors with protection Ip68 Type TMP	from 5,5kW up to 22kW 4 poles standard with 10m connection cable and 6m protection tube with special shaft (long or short)	PUMP DIRVE Agriculture, liquid manure, biogas, wastewater , sewage plant	
SUBMERSIBLE MOTORS	Special motors desinged and produced from FFD in close coordination with and especially for our customers. From the first idea to the final production.	for example: Submersible motor type: dSKLS (11 and 15kW) flame proof desing IIG Ex dIIA T4	MIXER Agriculture, liquid manure, biogas, wastewater , sewage plant	
HOLLOW SHAFT MOTORS	Three-phase induction motors with hollow shaft	Frame size: 100 up to 250 Poles: 2, 4, 6, 8, 12 and multiple speed	Suitable for agitators driving with special flange and hollow shaft (without propeller and shaft)	
MARINE MOTORS	Three-phase induction motors	PRS - polish register of shipping GL - German Lloyd ´s LRS - Lloyd ´s Register of shipping DNV - Det Norske Veritas ABS - American Bureau of shipping BV - Bureau Veritas RMRS - Russian Maritime Register of Shipping	Motors designed for use on ships. On deck or under deck. The motors are made to withstand aggressive environments such a salt mist.	
MOTORS FOR INDUSTRIAL FURNANCE AND BLOWERS	Three-phase induction motors	Motors used for air circulation up to 1200°C air temperature	Motors works in drying plants	
COOLING MEDIUM PUMPS	Three phase pumps or Single phase pumps	DKP with 115W EKP with 100W Dip length: 86mm, 120mm, 170mm, 220mm, 270mm 220-250/380-440V 50/60Hz	Work like centrifugal pumps. These pumps are quite resistant to the pollution of coolants. Manufactured in with 5 different dip length.	
BRAKES	Electromagnetic brakes	H2SP, HPS, 2H2SP, H2SPX H2SP...AT - quiet operation HPS...AT - quiet operation STE, STK - quiet operation 2H2SP...BT - quiet operation, NE - high level of protection NEX - explosion-proof version HZg - alternating current brakes	High standard and high repeatability even with large number of actuations.	
REPAIRS AND SERVICE	Electrical and mechanical repairs of all motor types Service and testing of all motor types Also motors from other manufacturers	for example: - new winding - new bearings - new shafts - new PTC, Pt100 or bi-metal switch - new painting (all RAL colors) - new name plate - Motor routine test	We are using only high quality materials for motor repair.	

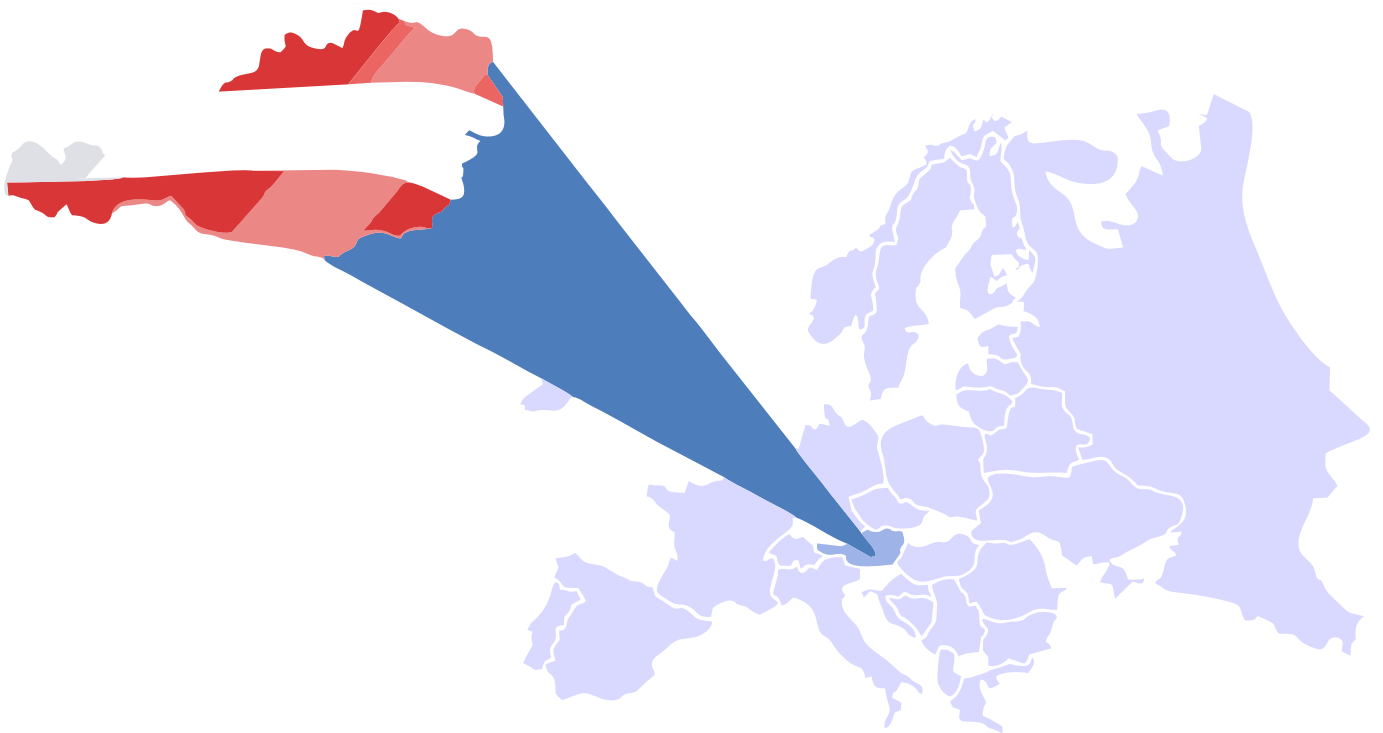

**FFD locadet in the heart
of Europe, AUSTRIA!**

FRANK & DVORAK

Elektromaschinenbau- und Vertriebsgesellschaft m.b.H. u. Co.K

CONTACT ADDRESS:

Industriestraße 1

A-7033 Pöttsching (Burgenland),

Phone: +43 2631 / 8005

FAX: +43 2631 / 8005 84

mail to: ffd@frank-dvorak.at

www.frank-dvorak.at